Chapter 5

Sensors

Sensors

Wolfgang Kornberger

1. INTRODUCTION	140
2. SENSORS (INSTRUMENTATION) BASICS	140
2.1 Terminology.....	142
3. SIGNAL TRANSMITTER.....	148
4. SIGNALS.....	151
5. SIGNAL TRANSMISSION.....	152
5.1 Current output	152
5.2 “DEAD ZERO” and “LIVE ZERO”	153
5.3 Power supply.....	154
5.4 4-wire and 2-wire transmitters	154
5.5 Non-isolating and isolating transmitters	156
6. CONTROL, ALARMING AND DISPLAY	158
7. MEASUREMENT USED IN THE CEMENT INDUSTRY.....	158
7.1 Temperature.....	158
7.2 Pressure.....	161
7.3 Flow (gas and liquids).....	161
7.4 Level.....	162
7.5 Weighing	165
7.6 Analytical measurements.....	171
7.7 Electrical energy and power measurements	172
7.8 Field devices	178

1. INTRODUCTION

When looking at the automation pyramid, it becomes obvious that instruments and sensors form the foundation for any control and automation. It is here where the information is gathered which is then used further in the automation pyramid for either:

- ◆ interlocking and control for automated production
- ◆ regulation with PID-controller and high level control to ease the workload of the operator and to improve the plant performance (reduce energy consumption and/or increase production)
- ◆ display and register process values to inform the management and the operator about the plant performance

Note: It is important to remember that it is impossible to control anything unless the parameters have been accurately measured in advance.

2. SENSORS (INSTRUMENTATION) BASICS

The task of an instrument or a sensor is to convert a physical value into an electrical signal. A signal is picked up with a primary element, then converted in the transmitter to an electrical signal and finally transmitted to a control centre where the signal is further treated for either display, alarming or control. (See drawing F44570-1)

The example in the drawing F44570-1 shows a pressure transmitter. The pressure (connected on either side) distorts the bellows. This deformation is moving a lever which is connected to a plunger moving in a coil. The movement of the plunger in the coil evokes an electrical signal which then is converted to a standard electrical signal of 4-20 mA.

All transmitters work on a physical principle which depends on the process media, the desired type of measurement and the accuracy required. Some principles are as simple as in the example in drawing F44570-1 given. Others, like gas analysers working on light diffraction are more sophisticated and therefore not only more expensive but as well prone to high maintenance.

Transmitter with Current Output

FIELD

CABLING

CONTROL ROOM

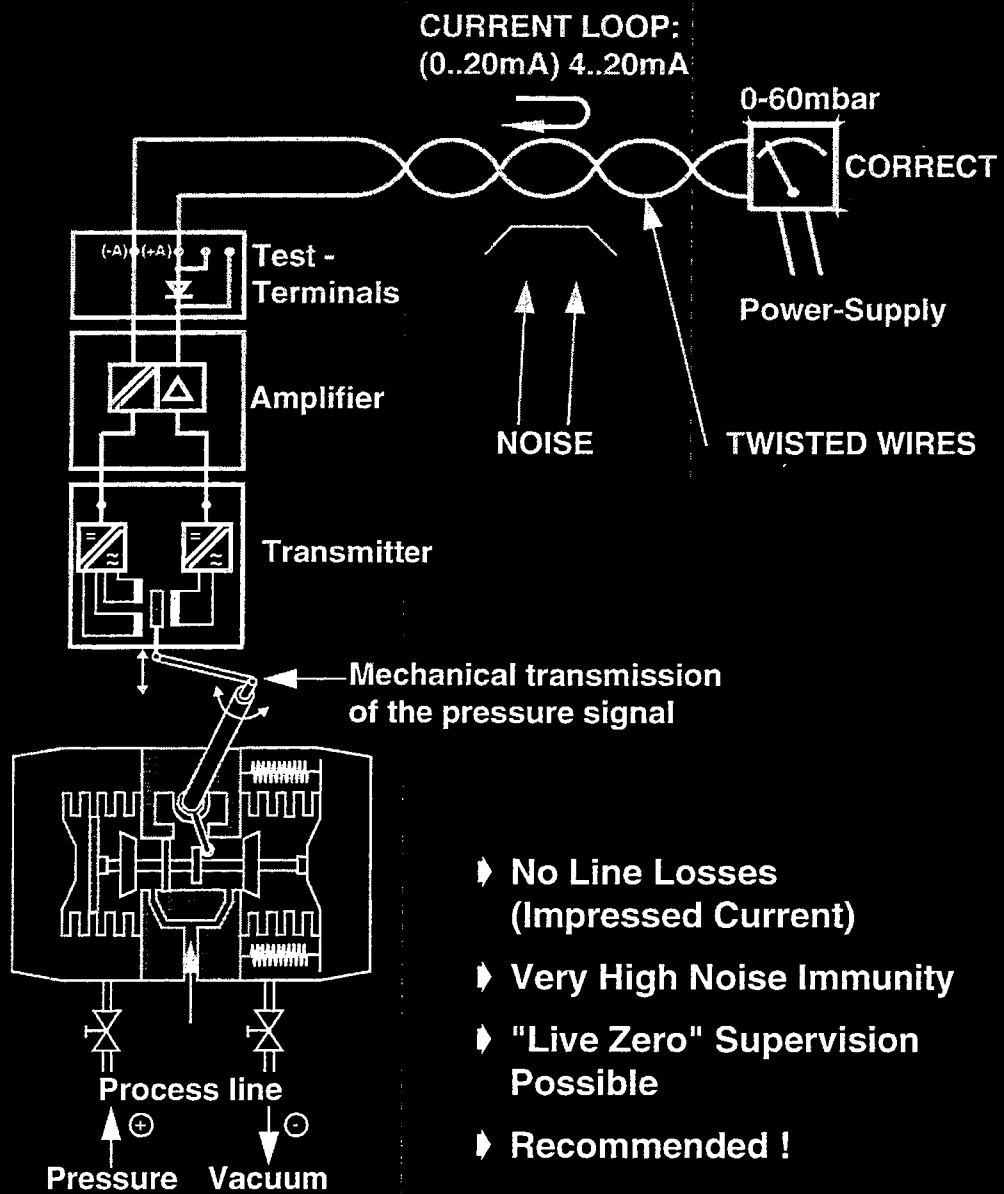

- ▶ No Line Losses (Impressed Current)
- ▶ Very High Noise Immunity
- ▶ "Live Zero" Supervision Possible
- ▶ Recommended !

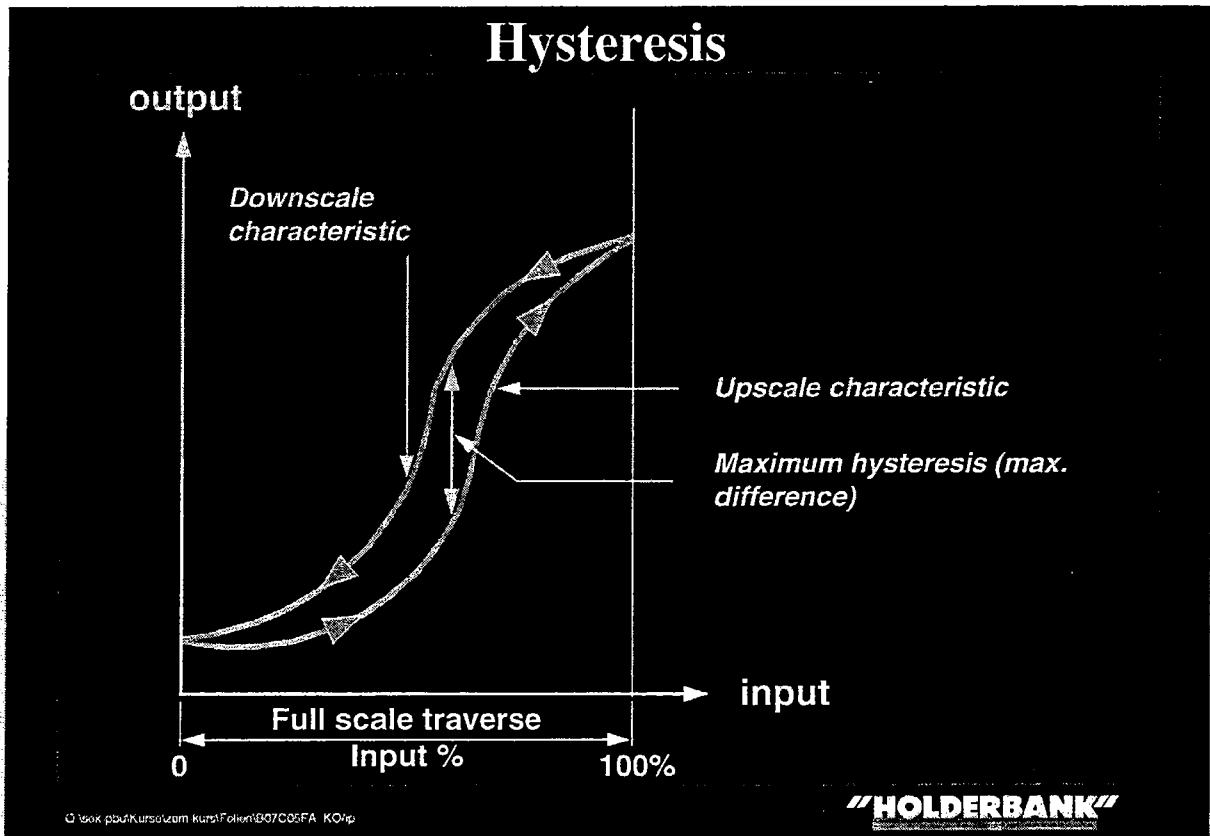

(Alarm limits for example are equipped with a hysteresis in order to prevent repeated signals around the alarm point).

- Impedance: Resistance of a network of resistors, capacitors and/or inductors.
- Interference: Noise (spurious voltage or current arising from external sources or interference between measuring circuit and ground).
- Input: Device to convert the electrical signal into a digital information for further treatment in a Process Station or Programmable Logic Controller (PLC).
- Linearity: The closeness to which a curve approximates a straight line.

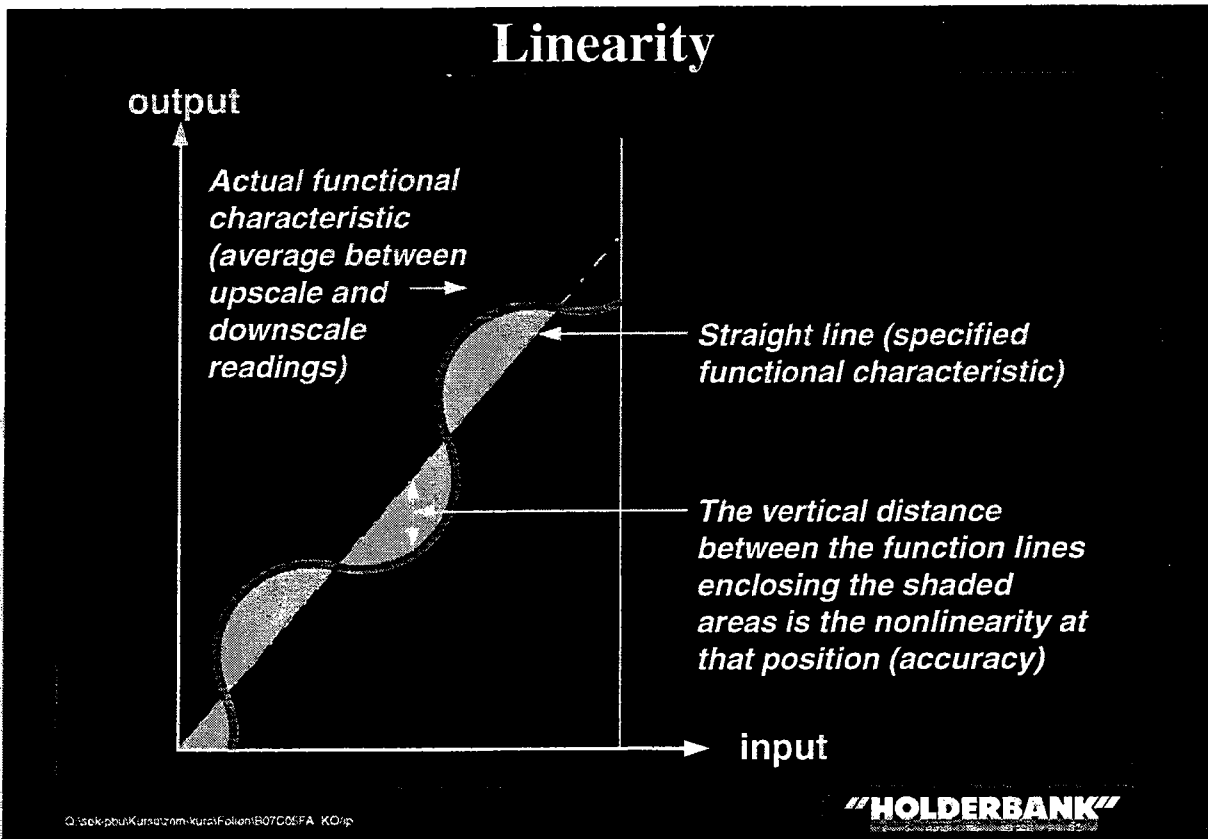

- Limit: Alarm limit
- Lag: (Time lag) time elapsed between process and measuring point as well as measuring point and control device.
- Noise: False signal picked up in the transmission line (see interference and signal-to-noise ratio).
- Output: Signal from a device (instrument).
- Range: Region between limits of measuring device expressed by stating the lower and upper range values.

Illustrations of the Use of Range and Span Terminology

Typical Ranges	Name	Range	Lower Range Value	Upper Range Value	Span	Supplementary Data
		0 to 100	0	+100	100	—
	Suppressed Zero Range	20 to 100	20	+100	80	Suppression Ratio = .25
	Elevated Zero Range	-25 to +100	-25	+100	125	—
		-100 to 0	-100	0	100	—
	Elevated Zero Range	-100 to -20	-100	-20	80	—

Q:\sek-pbu\Kurse\ram-kurs\Folien\B07C05FA_K01.p

"HOLDERBANK"

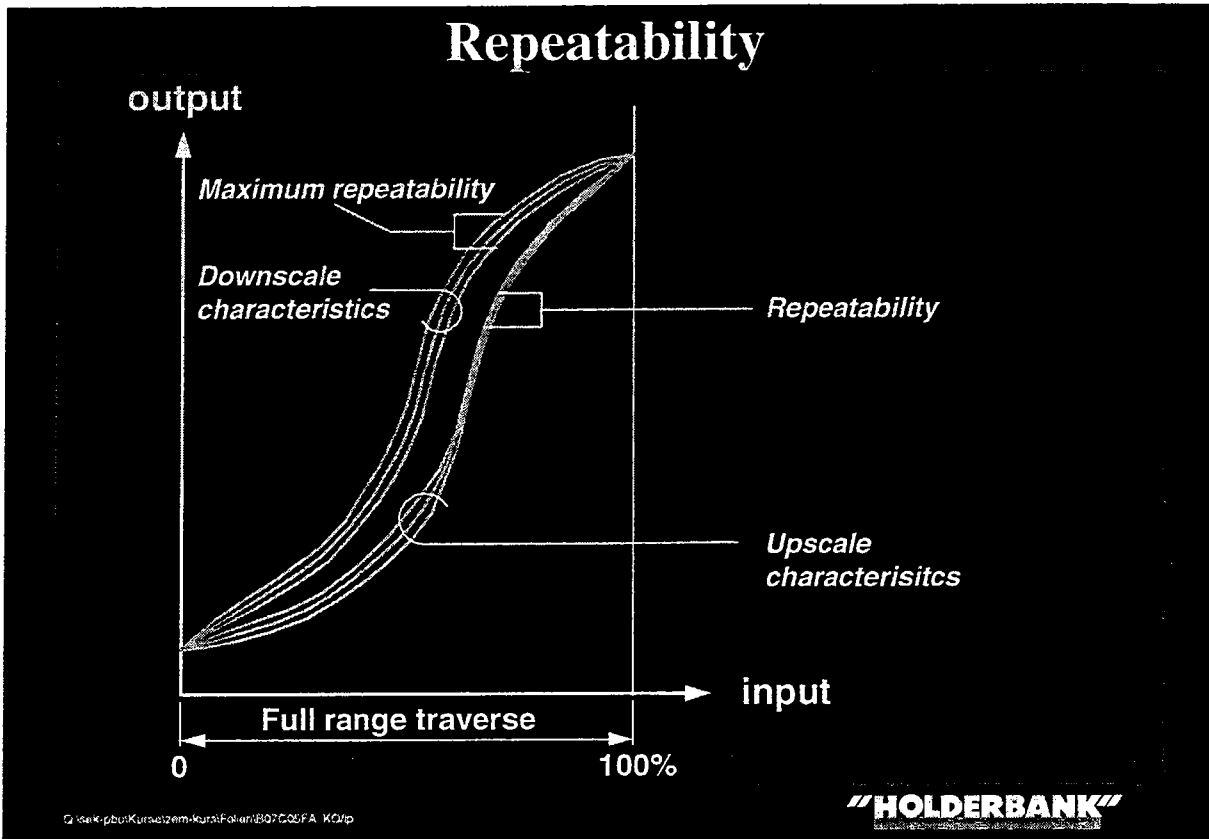

Response: General behaviour of the output of a device as a function of an input.

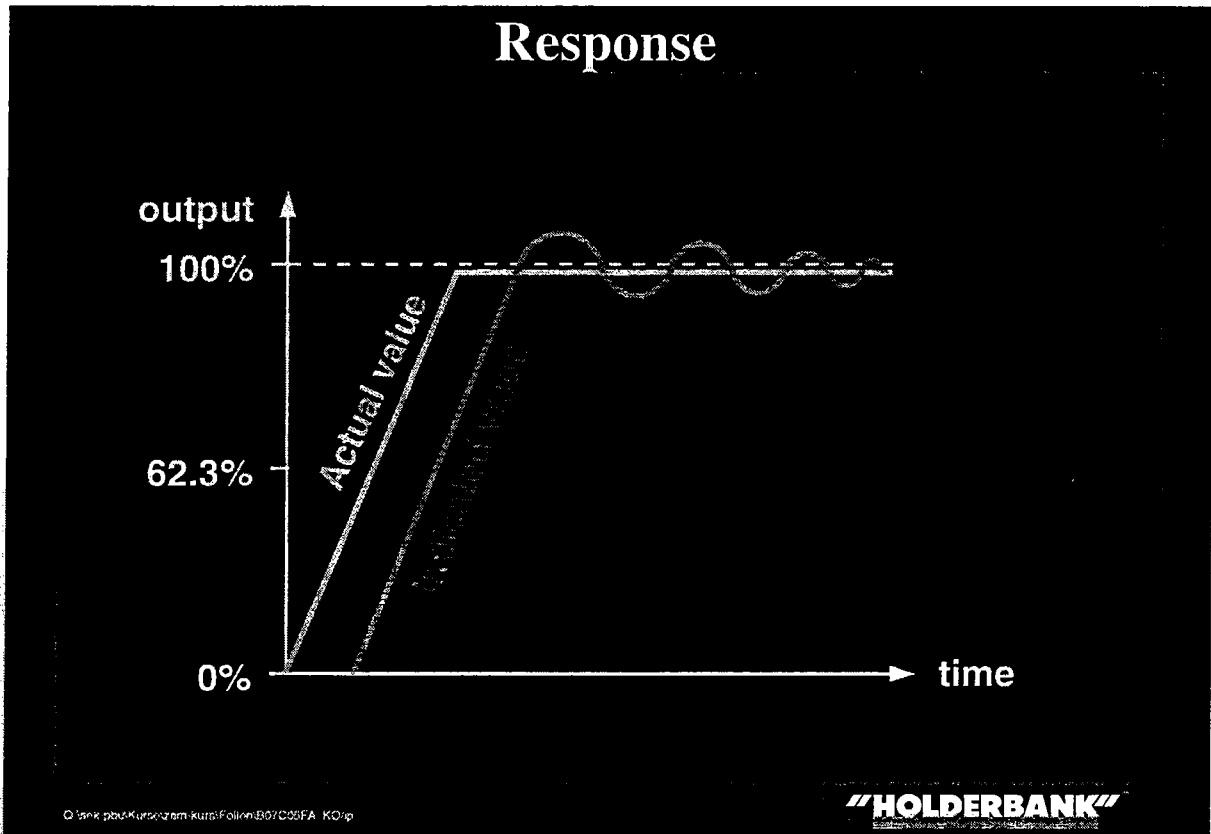

For additional information regarding PID control refer to the relevant paper in the process technology department.

- Sensitivity: (see deadband and gain).
- Signal to Noise Ratio: Ratio of signal amplitude to noise amplitude.
- Span: The algebraic difference between the upper and lower range values.
- Suppressed zero: The zero value of the measured variable is less than the lower range value. (Zero does not appear the scale).
- Time constant: Time required for an output of an instrument to complete 62.3 % of the total rise or decay.
- Zero: Zero point of scale (to be calibrated frequently due to zero shift resulting in parallel shift of the input output curve).

3. SIGNAL TRANSMITTER

As mentioned in the introduction, the task of the transmitter is to convert a physical signal into a suitable electrical signal. This electrical signal is then converted into a standard analogue signal of for example 4-20 mA or 24 V digital on/off. Other standard signals exist but the “Holderbank” standard analogue signal is 4-20 mA, for digital on/off signal 24 VDC (Exception America: 110 VAC).

It is, in most cases, necessary to calibrate or verify (adjust zero, span and range) a transmitter. Normal adjustments are Zero = 4 mA and Span = 20 mA. Thus the actual electrical signal representing a process value of 0 - 100% is represented by 16 mA. Calibration is usually performed by simulating the physical signal. Thus, a true zero and if feasible a 100% signal should be evoked in order to calibrate the transmitter over the entire range. The smaller the range of the calibration signal is the more inaccurate the calibration. Each type of instrument transmitters requires its particular way of calibration. It is therefore mandatory to provide the proper instruments for calibration purpose. Additionally, it is important not only to calibrate the transmitter but the entire instrument loop. Thus, the transmission and the signal treatment in either a display instrument or a PLC must be included in the calibration procedure. (See drawing F44570-1)

Some modern instruments require an initial calibration during commissioning and only an occasional check up during their lifetime. Others, like for example power transducers cannot be calibrated nor do they require any adjustments since they are factory precept.

The instruments described above are analogue instruments. That's why the signal varies continuously between 0 and 100%. Often, however only one single point is required. For such a purpose a sensor with an on/off output is sufficient. It saves programming of an alarm limit in case a PLC is used, respective the use of an extra alarm device to produce a thresh hold. However, using an on/off device only can be controversial since this device cannot be checked about its proper function. A 4-20 mA signal can be supervised if it is functioning properly (signal <20 mA and signal >4 mA). An on/off signal can be connected fail safe (contact closed under healthy condition) and a dynamic supervision (contact changes when the process is stopped) included but an analogue signal is easier to verify.

The trend of automation in process engineering leads to “intelligent” field devices. A new generation of instruments called “smart sensors” is on the market. A smart sensor cannot only perform its dedicated task (e.g. measure the temperature) but monitor its performance at the same time. These smart sensors are microprocessor-based field instruments which are designed to communicate with a control unit. A lot of these sensors are operated via hand-held terminals or PC's. Usually the signal picked up by the primary element is converted into a digital signal by an analogue to digital converter. The digital signal is linearized, ranged (0-100% as required), dampened and if required multiplied or squared. The micro controller also controls the digital-to-analogue signal converter for 4-20 mA output and drives the digital communication.

Configuration- and sensor linearization data are stored in a non-volatile EPROM memory. The control unit communicates via a superimposed digital signal over the 4-20 mA signal or via a bus with the smart sensor.

Each manufacturer has his own communication carrier (bus or via frequency shift keying FSK) over the 4-20 mA signal and his own protocol. Usually communication is performed without interrupting the control loop. Some of the following tests and functions can be carried out via link, smart sensor and control unit:

- ◆ loop test of the 4-20 mA signal
- ◆ inject a specific mA signal and check the display
- ◆ check the configuration data and call up its values
- ◆ check changes of the performance of the smart sensor
- ◆ name (tag) a device and give an alarm or message text in the smart sensor. Store data about spare parts for the device.

Today, neither in the operator control unit nor in the operator philosophy a compatibility or standardisation is discernible. Due to this situation user acceptance is very low. Additionally, the tasks as mentioned can be performed by the “normal” transmitters connected to a PLC. Thus, it remains questionable to whether smart sensors and Profibus are required today for the cement industry.

The enclosed instrument list shows the most frequent measurements applied in the cement industry and the approximate amount of instruments. The number of measurement, approximately 3000, applied in a modern cement plant is quite impressive. And the tendency is certainly not diminishing in the near future. Especially in connection with environmental control and with rising energy prices, the number of additional measurements will increase.

Measurement	Application	Typically installed	
		Analog	Digital
Active Power	Current- and Voltage Transformer	200	2
Position	Inductive, Potentiometric, Capacity, Proximity, Mechanical	50	1000
Electric Voltage	Voltage Transformer	4	
Electric Current	Current Transformer, Thermal overload	4	1000
Level	Electro-Mechanical, Sonar Systems, Capacity, Radioactive	50	100
Speed	Tacho-Generator, Inductive and Magnetic (Proximity Type)	40	100
Flow (Volumetric) Liquid, Gas	For Gas Flow: Venturi, Orifice, Pitot-Tube; For Liquid Flow: Turbine-, Piston- and Oval Type Counter, Electro Magnetic	15	50
Flow (Solids)	Belt Weigher, Impact, Flow Meter, Nuclear Belt scale	20	
Temperature	Thermocouple, Resistance, Thermometer, Radiometric	400	
Weight (Mass)	Load Cells, Strain Gage	30	
Pressure	Barton-, Bellows-, Diaphragm Cell Burden Tube, Pizo Crystal	40	20
Sound Level	Sonic Detector, "Electronic Ear" (Microphone)	2	
O ₂ Content	Paramagnetic Oxygen Analyzer, Zirconium Oxide Probe, Electrochemical Cell	6	
SO ₂ , NO _x	Infrared Absorption	2	
CO	Infrared Absorption	4	
Dust	Opto Electronics/Light Absorption	2	
Closed Circuit Television	TV Camera and Monitor Kiln, Cooler, Raw Mill Feed, Crusher Feed	2 4	
Around 900 Analog	2200 Digital = 3000 Sensors + 2000 Control Elements + 2000 EL Circuit Protection		

4. SIGNALS

When talking about signals at first two different sides must be distinguished:

- ◆ the primary side is the actual physical measurement which is detected with the primary element (e.g. thermocouple, diaphragm of a pressure transmitter)
- ◆ the secondary side is the signal leaving the transmitter and being transmitted back to the control centre.

This and the next chapters deal with the signal transmitted to the control system since this is an important factor for the installation. When looking at the secondary side of the signal transmission four different signals have to be distinguished:

- 1) Analogue signal → current e.g. 4-20 mA DC, or voltage e.g. 2-10V DC
- 2) On/off signal → on/off e.g. 24V DC
- 3) Pulse → frequency e.g. speed detector pulse
- 4) Field Bus → code e.g. 500°C as a BCD code

The cement industry is concerned with all four types of signals. In the field it is mainly the analogue 4-20 mA and digital 24V DC; to a lesser extend with pulses and, if at all, they are converted as soon as possible to an analogue signal. The classical cement industry was not concerned with a bus except for communication between PLC's or computers. However, the market shows that the near future is in the application of the Fieldbus. The respective standards are set and respective commercial advantages result. The signals 1) - 3) will become less important.

5. SIGNAL TRANSMISSION

For safe and efficient operation of the plant it is most important to have a reliable signal transmission between the field, - where the signal is generated, - and the control room, - where it is used for indication, recording, limit supervision, process control etc. The distances from the field to the control centre may range between 100 meters and 1000 meters, or more. And it is well known that problems with electrical disturbance, interference, noise and losses, increase with longer transmission distances.

For signals as mentioned in the previous chapter, several alternatives for the long distance transmission are applied; some of them are becoming obsolete due to new developments in the field of electronic components. The simplest method would be to run any sort of signals (pressure, electrical) back to the control room as performed in the early stage of instrumentation when the control centre was local and closed by. On the example of a thermocouple (TC), the problems encountered are discussed.

Is it possible to run a thermocouple extension wire with a mV signal all the way from the thermocouple junction to the indication in the control room? Why not? Mainly because the thermocouple extension wire is expensive. And unless it is very well shielded, which adds to the expense, it will pick-up all sorts of unwanted noise from radio transmitters (walkie-talkies), motors, high voltage cables etc. Since the signal from the thermocouple is only a few milli-volts to begin with, any noise is a problem and it doesn't take a lot of noise to blanket the signal entirely. Such a millivolt signal cannot be transmitted together with other signals in a multi-core cable and it cannot be brought to several users in parallel, such as to an indicator and a recorder, although PLC's with TC input exist.

Though, it is true that in some instances by using thermocouple wires over a long distance and achieving satisfactory results, the odds are against it, making it a risky method to try in a cement plant!

Even the idea to amplify the voltage signal (to reduce the signal to noise ratio) is not good enough since the noise picked up may be several hundred volts high.

5.1 Current output

If a thermocouple transmitter with 4-20 mA DC (or 0-20 mA DC) current output is used, instead of a voltage output, some important advantages are gained. The controlled current line eliminates losses due to the wire resistance (line losses), because the resistance of the wire merely drops voltage along the line - the current remains constant (impressed current). Also, the noise pick-up is all but eliminated by the very high noise immunity of the current line due to the very low output loop impedance.

This allows to use a twisted pair of ordinary signal wires. The wires are twisted, so that any noise that appears on the line will be on both lines. It can be eliminated by means of specific electronic circuits at the input of the upstream connected instrument. (= "common-mode rejection", meaning the ability of a circuit to reject signals of equal amplitude on both input leads.)

Current signals can be collected in the field (field junction box) and transmitted to the control room with low-cost multi-core cables.

Summarising, it can be said that the beginning of the measuring range of any type of analogue measurement is represented on the transmission line by a current of 4 mA (or 0 mA). The end of the measuring range of any type of measurement is represented on the transmission line by a current of 20 mA. That means, an unscaled value in electrical units is transmitted. To produce an indication scaled in the desired physical unit the indicator has to be provided with the respective scale.

5.2 "DEAD ZERO" and "LIVE ZERO"

In a standard 0-20 mA the zero-point of the measuring range e.g. 0°C, is represented with 0 mA ("DEAD ZERO"), and the end-point of the measuring range, e.g. 150°C, is represented with 20 mA signal current. However, the signal current also becomes 0 mA (no current flow), in case of a transmitter failure, broken cable, or loss of power.

In a standard 4-20 mA the zero-point of the measuring range e.g. 0°C is represented with 4 mA (live zero) and the end-point of the measuring range e.g. 150°C with 20 mA. Therefore, for the transmission of an analogue measurement, only a range of 16 mA is available.

A signal current of 0 mA (no current flow, or a current <4 mA), can only be caused by a transmitter failure, broken cable or loss of power. Thus, the 2 cases "FAILURE" and "ZERO-POINT of MEASURING RANGE", can easily be distinguished.

An electronic circuit can monitor the measurement-loop with "live zero" and immediately generate an alarm if a failure occurs.

Loop Supervision with "Live Zero"

STANDARD SIGNAL : 0...20mA

ACTUAL INDICATION:
0°C
OR
0 mA

INDICATOR

STANDARD SIGNAL : 4...20mA

ACTUAL INDICATION:
0°C
(4mA)

Similar on a computer display !

ACTUAL INDICATION:
0°C
(0mA)

Under + Overflow

"HOLDERBANK"

© 1998-2000 Holderbank Management & Consulting, 2000

5.3 Power supply

A 2-wire transmitter can only operate with a “live zero” standard signal (4-20 mA), because the first 4 mA are used to supply the electrical power to the 2-wire transmitter, 4-wire transmitters are available with “live zero” (4-20 mA), or “dead zero” (0-20 mA), standard signals.

5.4 4-wire and 2-wire transmitters

4-wire transmitters need 2 wires for the transmitter operating power supply and 2 other wires to transmit the output signal to a remote location for indication or other purposes.

2-wire transmitters need 2 wires only to bring the power to the transmitter and to transmit the output signal. The basic idea is to use the first 4 mA of the output signal to cover the transmitter’s power consumption and the remaining 16 mA for signal transmission.

4-wire transmitters are available for any DC or AC power supply voltage. The output signal is usually a standard signal of 4-20 mA or 0-20 mA DC. The admissible external burden can go up to 3000Ω; however, a typical burden is 500Ω.

“Zero” and “span” are independently adjustable, which facilitates the commissioning and calibration of a transmitter. To prevent electrical disturbances caused by “earth-loops” only transmitters with **galvanical isolation** between power supply, input and output should be applied. Where feasible interconnections between measurement loops should be avoided. (See also the chapter “Non-isolating and isolating transmitters”.)

Summary

Goals and drawbacks of the 4-wire concept:

- ◆ “Compact transmitter”, i.e. power supply is integrated in the transmitter.
- ◆ Large variety of power supply voltages possible (220 V, AC, or 110 V AC is already available at most locations of the plant).
- ◆ 4-wire transmitters can perform all measuring functions between “very basic” and “very complex”.
- ◆ Independent “zero” - and “span”-adjustment.
- ◆ Very high external burden possible.
- ◆ Output signal 4-20 mA or 0-20 mA possible.
- ◆ Cabling and installation expensive, due to separate power supply cable.

The 2-wire transmitter converts the input signal to a standard output signal of 4-20 mA and receives its power from the same 2 wires.

The output signal consists of two components:

- ◆ The 4 mA component (also called “live zero”), is a constant drain on the remote located power supply. This current is used to provide operating power to the transmitter.
- ◆ The second component, 0-16 mA, is a variable drain on the power supply that is proportional to the transmitter’s input signal, which may represent a temperature, pressure, flow etc.

Working principle of 2-wire transmitters

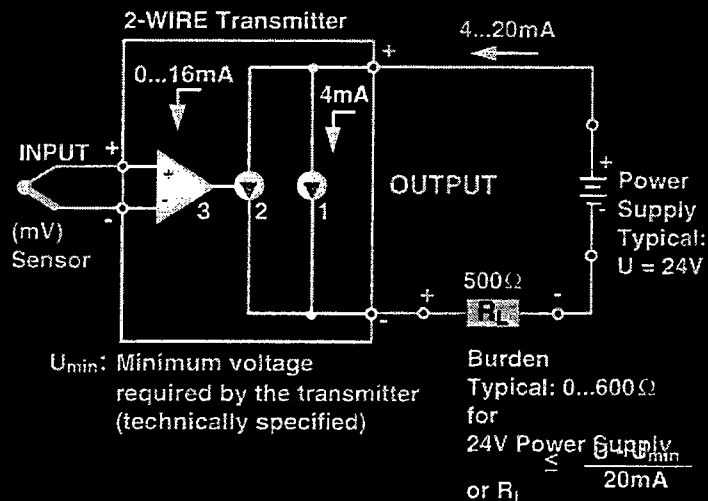

- 1 4mA Constant Current for Transmitter Operating Power
- 2 0...16mA Variable Current, Proportional to the Input Signal ("Current Valve")
- 3 Input Amplifier

"HOLDERBANK"

© Holderbank Management & Consulting, 2000

The sum of these two current components results in a 4-20 mA current that flows in the measurement loop at the transmitter's output. It is obvious that 2-wire transmitters may operate only with the "live-zero" standard signal 4-20 mA. The typical measurement loop in 2-wire technology shows the power supply, the transmitter and the receiving elements, such as analogue inputs, indicators, recorders etc., connected in series with the loop.

Usually the power supply is located in a "clean room", e.g. in the control centre, however, the transmitter in a dust and water-proof housing is placed "in the field", next to the detecting point.

2-wire transmitters using the most advanced electronics technology may operate with power supply voltages between 12 V, DC and 50 V, DC. The admissible maximum burden connected to the output loop depends on the power supply voltage.

In the 2-wire mode it is technically impossible to provide independent adjustments for "zero" and "span". Therefore, calibration and maintenance is slightly more time-consuming and needs more experience compared with 4-wire transmitters.

5.5 Non-isolating and isolating transmitters

While driving grounding rods into the ground at two points several hundred meters apart and connecting a voltmeter between them, a voltage difference becomes noticeable.

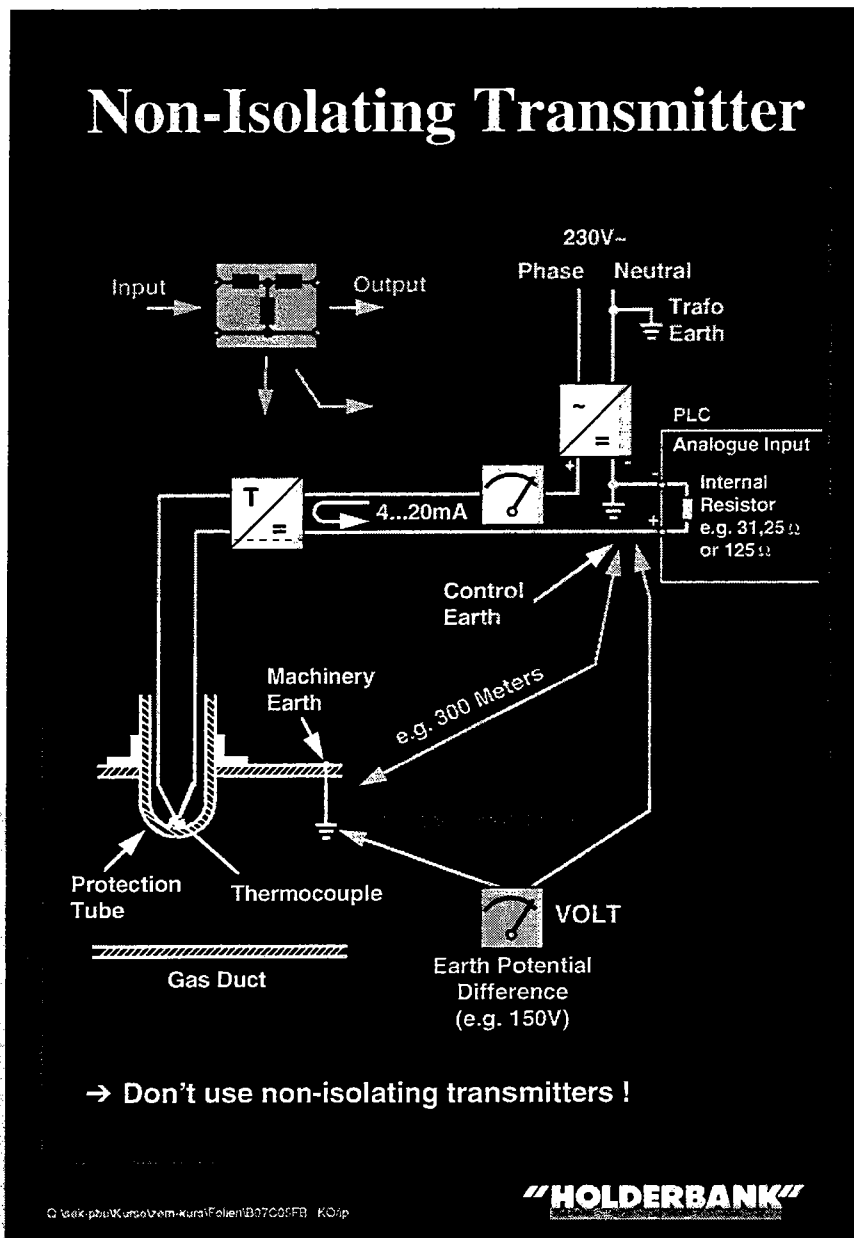

This potential difference exists between practically any two points along the earth's surface. From this resulted voltage problems can cause when trying to measure a process at a remote location.

It is necessary to ground the sensor at the remote site to reduce noise and to protect the equipment from damage caused by lightning. But if grounded thermocouples are used and if it's tried to ground one side of the transmitter output loop at the control room, the voltage difference between the two points will induce an error current along the line, resulting in an erroneous measurement indication or in equipment damage!

To eliminate this "ground loop", an isolating transmitter can be used. This type of transmitter electrically isolates the transmitter's output loop from the sensor signal as well as - in case of a 4-wire transmitter -, from the power supply, and allows to ground both, the sensor and one side of the output loop.

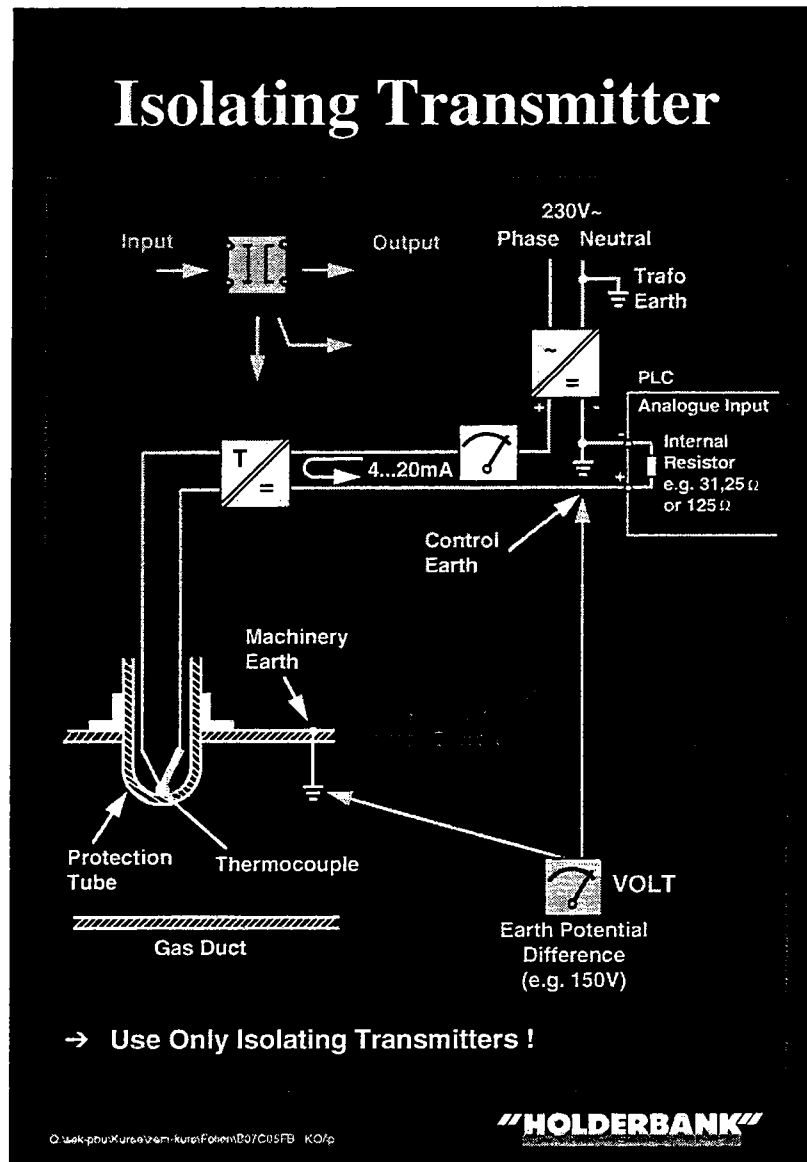

Everybody knows: a transformer can transform only alternating current (AC). Actually, that's the reason why direct currents (DC) are first converted into AC, then transformed by the transformer and finally rectified again to obtain DC, reproducing exactly the DC at the module's input.

Recommendation, Conclusion

- ◆ The induced error current, caused by the earth potential difference or by lightning, can cause erroneous measurements and equipment damage!
 - Do not use non-isolating transmitters!
- ◆ The galvanical isolation in transmitter and power supply opens the induced error current path!
 - Use only isolating transmitters! Galvanic isolation between signals and power supply.

6. CONTROL, ALARMING AND DISPLAY

When the signal at the desired location (e.g. central control room) arrives it has to be further treated either for display, recording, alarm or control. In a modern cement plant the 4-20 mA are fed directly into the Process Station (PS). This is the simplest method since any measurement can be used for any purpose without any further effort provided a good standard and user software is installed in the PS. How the signal is treated further can be read in chapter “Motor Control”.

7. MEASUREMENT USED IN THE CEMENT INDUSTRY

The cement industry uses in most cases common instruments but faces some cement specific problems. As shown in the instrument list, the cement industry applies not too many different types of sensors, respective measuring principles. However the tendency is increasing.

Problems are encountered mainly with high temperature, clogging and coating. Many of these problems can be evaded by selecting the proper instrument, respectively primary element and/or picking a suitable location. Maintenance and regular calibration avoid break downs and prolong the lifetime of the primary element.

Note: To facilitate easy maintenance, accessibility of the primary elements and the transmitter is vital.

Cement specific sensors and measuring systems are illustrated in the next chapters.

7.1 Temperature

In the cement industry generally thermocouples, PT 100 resistance bulbs and pyrometers are used. For kiln shell measurement, temperature scanners are often applied together with a display system. These scanner systems range from a simple pyrometer connected to a recorder or from a scanner head connected to a PC with an elaborated software giving information about the shell temperature, interpretation about the inside of the kiln and even a brick management and slip detection can be included.

7.1.1 Thermocouple

Mostly applied for temperature measurement in the cement industry are thermocouples which use the peltier effect as measurement principle. A thermocouple consists of two dissimilar metals. Between these metals a voltage is generated. The electro-motoric force (emf) developed by a thermocouple depends on the temperature of both, the measuring (hot) junction and the reference (cold) junction.

Important for a thermocouple is therefore:

- ◆ the type of thermocouple and the manufactures data (e.g. type K thermocouple)
- ◆ the extension cable of the appropriate type (e.g. type K for type K thermocouple)
- ◆ temperature range and type of thermocouple (e.g. type K for 200 - 1200°C)
- ◆ cold junction reference temperature 0°C, 20°C or others.
- ◆ the type of protection sheath. The length of the TC as well as the protection tube should be standardised (e.g. 800 mm and 1200 mm). The material for the sheath may however be different for various applications since a high temperature protection sheath is very expensive.

To calibrate a transmitter for a thermocouple, a mV source is required. This source is connected in the measuring loop instead of the thermocouple. According the manufacturer's

data sheet, mV for 0°C and mV for the maximum temperature are fed into the loop. Then the output of the transmitter 0°C = 4 mA and max. temperature = 20 mA are checked as well as the display in the control room together with any alarm limits. The temperature range from -200°C up to +2000°C can be covered with thermocouples.

7.1.2 Resistance bulb RTD PT 100

For lower temperature (e.g. for machine protection) resistance thermometers are used. RTD's work on the principle of a resistance changing when the temperature varies. Mostly used in the cement industry is the Pt 100 platinum resistance bulb. The PT 100 has a resistance of 100Ω at 0°C and 158.8Ω at 150°C. When selecting a resistance bulb, it is important to specify a 2-, 3- or even a 4-wire type. To compensate for the line resistance a 3-wire type normally is sufficient. If the transmitter is installed nearby, even a 2-wire bulb is good enough.

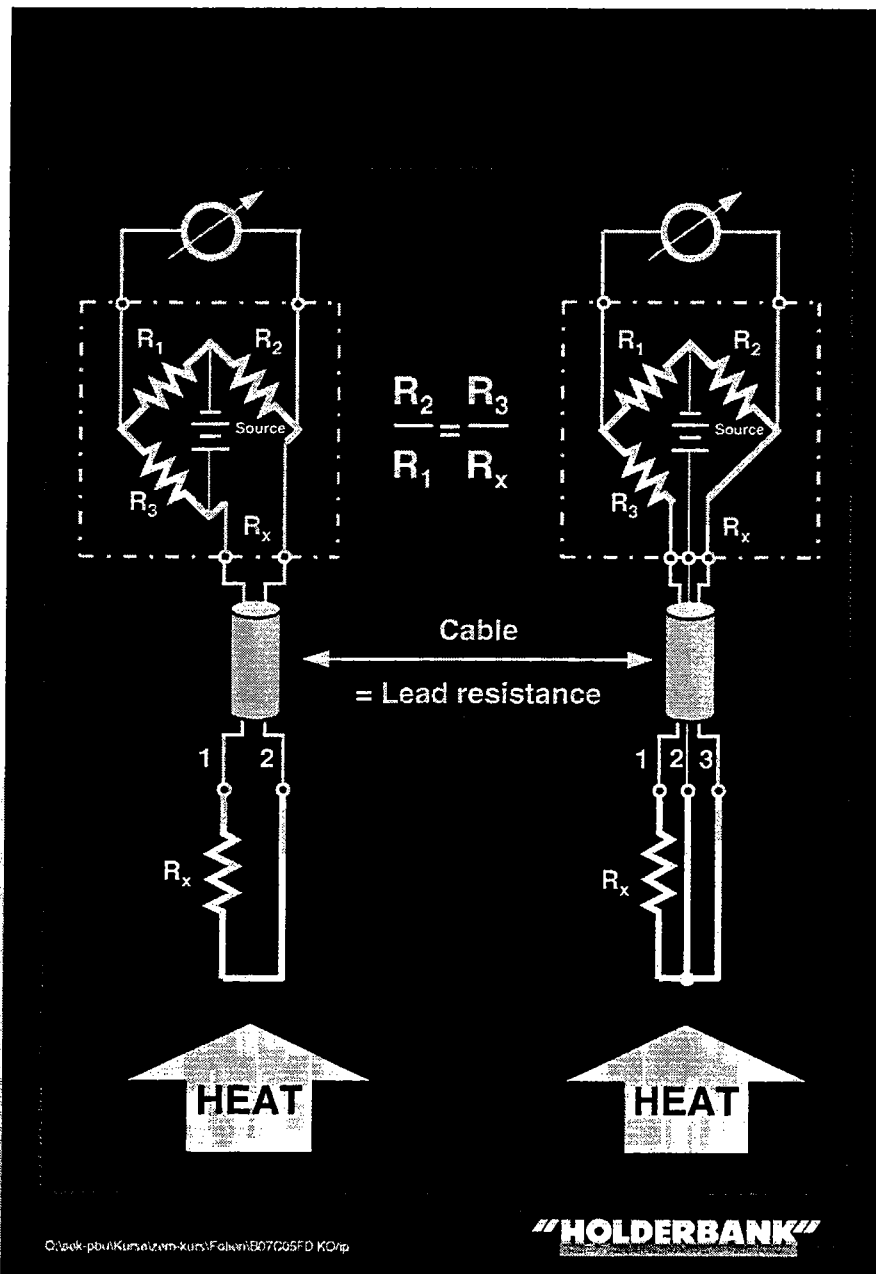

To calibrate a transmitter for a PT 100 a resistance decade is required. This resistance box is connected in the measuring loop instead of the PT 100. According the data sheet the

base resistance (e.g. 100Ω for PT 100) for 0°C and the maximum resistance for the maximum temperature (e.g. 158.8Ω for PT 100) are fed into the loop. Then the output of the transmitter $0^{\circ}\text{C} = 4\text{ mA}$ and max. temperature = 20 mA are checked as well as the display in the control room together with any alarm limits. PT 100 transmitters require initial calibrations of the entire loop. After that only an occasional check up is required. With PT 100 bulbs temperatures from -250°C up to $+1000^{\circ}\text{C}$ are measurable.

7.1.3 Pyrometer

The cement industry uses two types of pyrometers. The radiation pyrometer which detects radiation through an optical lens system onto the thermopile or photo cell and the two colour ratio pyrometer which compares the ratio of the radiation intensity of two different wave lengths.

7.1.4 Scanner

The central feature of a scanner is a motor driven optical system which scans the entire kiln with a certain frequency (e.g. 16 Hz). The front of the scanner measures parallel along the axis of the kiln, in the back of the scanner a reference temperature is used to calibrate the system.

7.2 Pressure

Pressure can be measured either as liquid column (e.g. U-tube) with a mechanical principle (e.g. diaphragm, burden tube) or electrically (e.g. piezo crystal, strain gauge). The pressure measured in the cement industry is usually very low. Therefore, the differential pressure (gage pressure that is the difference between the absolute pressure and the atmosphere) is measured. Most pressure transmitters applied in the cement industry are of the mechanical type where one side is connected to the process and the other side is left open to the atmosphere.

Drawing F44570-1 is a typical example of a differential pressure measurement. The bellows are subjected to a pressure change and move, via mechanical links, a plunger in an electrical field. The electronic senses the movement and converts the change in the field into an electrical standard signal.

To avoid problems with pressure transmitters some installation points have to be observed:

- Location: locate the transmitter near the pressure tapping easy accessible. Mostly applied as unit by the manufacturer.
- Process line: the pressure tapping can be above or below the transmitter. In any case the process line must be installed such that no water or dirt can accumulate. Thus, always have at least 2% slope in the process line. If the tapping is above the transmitter a water trap is required.
- Tapping: install a tapping in such a way that cleaning is easily possible. Thus, a simple removable cover should allow pocking of the process tapping.

In large ducts two or more tappings connected with each other give a better result.

To calibrate a pressure transmitter a pressure source is required. This source is connected in the measuring loop on the primary side of the transmitter. To check the zero both sides of the transmitter are left open to the atmosphere. To check the maximum, an equivalent pressure (or vacuum) is applied. The output of the transmitter 0 kPa = 4 mA and max. pressure = 20 mA are checked as well as the display in the control room together with any alarm limits.

7.3 Flow (gas and liquids)

Flow measurement is thoroughly discussed in the corresponding paper of the process technology department.

7.4 Level

Level measurements, whether continuous or just as level alarms are often applied and often not 100% satisfactory. A poll carried out in 1992 querying the performance of the different level measurements in some 30 factories showed results from very satisfactory to useless. Depending on the method applied, the installation and the maintenance the same level measurement is rated different with regards to performance. The following level measurements are used successfully in the cement industry. Some mechanical types like paddle, ball etc. are not explained since their function is very simple.

7.4.1 Capacity probe

The capacity probe uses the measuring principle of two plates being isolated by a dielectricum ϵ where the capacitance depends on the area of the plates, the distance between the plates and the medium between the plates the dielectricum. When installing a capacity probe, the plates (the probe and the silo wall) are fixed and the distance is fixed provided, the probe is mounted properly. The variation in the measuring loop is therefore the dielectricum ϵ which is formed either by material between probe and wall or air. The following problems may occur thus hampering the performance:

- ◆ sticky material on the probe. This can be avoided using the proper type of level probe that is insulated or partly insulated probes.
- ◆ probe installed too close to silo wall thus evoking bridging.
- ◆ sensitivity adjusted to fine. Humidity in the air or in the material changes the property of the dielectricum.
- ◆ mechanical damage may result from coarse material or from sheer force. (E.g. coal dust has very high sheer force). Use an other measuring principle or use an insulated capacity probe.

7.4.2 Vibration

The vibration fork level probe is only used for a single point measurement. A driver induces a vibration in the probe and a controller senses a change when material dampens the vibration. The tuning fork is obtainable in two forms, one being the actual fork and the other in form of a tube. The following problems may occur thus hampering the performance:

- ◆ material stuck between the fork. Use a tube type to avoid this problem mostly occurring with coarse material.
- ◆ material coating the probe. Use the fork type probe since this problem takes place mainly with fine material.

7.4.3 Electro mechanical

Quite successful practice is the level measurement with the so called silo pilot. A rope or measuring tape connected to a weight is lowered into the silo. As soon as the weight touches the material surface, the rope (tape) tension ceases, the motor reverses and pulls the weight back into its original position. During the upward travel the tape is measured, such giving an indication of the level within the silo. The following points have to be considered by using a silo pilot:

- ◆ position on top of the silo so that no material can fall onto the weight. When lowering the weight it should be in the centre of the material cone.
- ◆ access to the rope respective belt and the weight must be easy. Install an inspection door to assist maintenance.
- ◆ select the proper weight for the corresponding material

7.4.4 Contactless level probes

Several methods allow level measurement without being in contact with the material. Ultra sonic is the most popular and is used with coarse material, e.g. gypsum, limestone. In connection with dust in the sonic beam or on the material surface <40°C, e.g. cement, raw meal, this method should not be applied. Level can be measured up to 45 m under good conditions. Rather new on the market are infrared and radar. With infrared no experience has been gained. Good experiences have been gained with radar in environment where ultrasonic fails. In clinker and in raw material silos the measurement with radar proved to be successful even with high dust load. In raw meal the measurement did not work and the problem seems to be the conductivity. Only material with a certain conductivity respective a low dielectricum can reflect the radar beam. Up to now only measurements for 35 m depth are available. This is due to the strength of the source which must be within the limit of the wireless regulation of the respective country. The radar method works in a temperature range of -40°C up to +250°C.

7.4.5 Radiation level probes

Well-known and well-proven are the nuclear type of level probes. From a measurement technical point of view no restrictions are known. In most cases where all other methods fail the nuclear level probe serves well almost maintenance free. In many countries, however, importing or handling the source is very difficult. Additionally the disposal of the source is in many cases almost impossible and requires a lot of responsibility of the person in charge. And more restriction for the future are to be expected.

An alternative (even in the pre-heater cyclones) offers the micro wave level measurement. The arrangement is similar to the nuclear level measurement a microwave source on the one side and a detector on the other side. The microwaves beam of approx. 20° angle, some 5.8 GHz or as high as 24.125 GHz penetrates any non-conductive material. The maximum distance through air is around 8 m.

Alternative measurements around the corner are possible if the space is limited. The installation must be such that a light beam would be properly reflected.

Microwave instead of nuclear level detector

Guide plate and distance to protect source and detector from heat

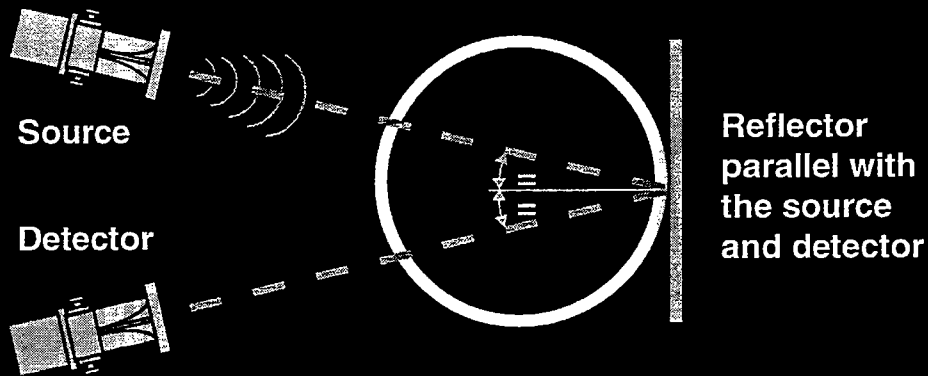
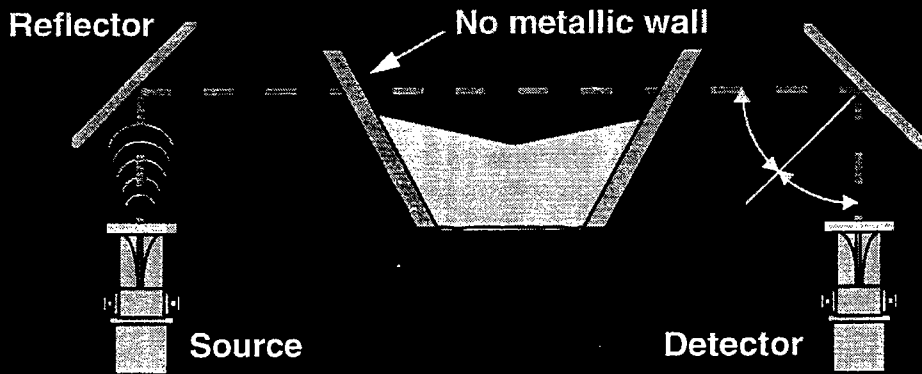
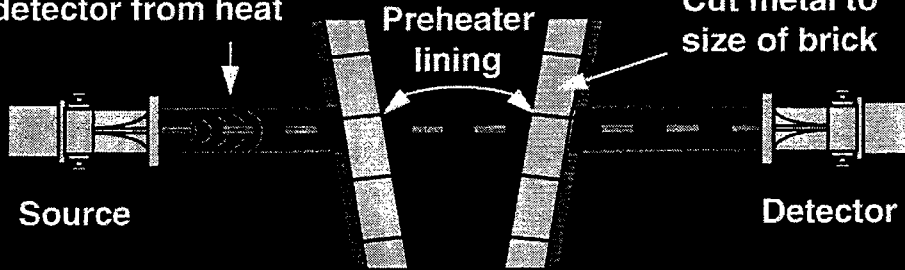

"HOLDERBANK"

Q:\sok-pbu\Kurse\zem-kurs\Folien\B07C05FD KO.jp

Microwave level measurements are sensitive to moisture. In fact, microwave is used as well for moisture measurement. The microwave source is so weak, that no danger comes from the measurement. (No cooking can be done with this microwave source, the energy emitted is less than 25 mW.)

7.5 Weighing

Weighing and weigh feeder play an important role in the cement industry. To produce a good cement quality, accurate weigh feeding of the different components is important. To bill the customer agreeable again, weighing plays the key role. Already these two important requirements show that for weighing two different ways are possible: the static weighing (weigh bridge) and the dynamic weighing (weigh feeder).

The weigh bridge at the factory entrance is regarded as the most important and accurate unit. The weigh bridge is in many countries subjected to stringent government regulation and must be checked and calibrated on a regular base. For weigh bridges the measuring principle applied is usually one or several load cells. Due to the strict government roles and due to the simple measurement principle these scales usually are fairly accurate.

Small bins are as well placed onto load cells to weigh the contents. And, as long as the construction is suitable, that is three load cells, free moving construction and protection against wind, the measurement can be very accurate. The total weight (xy tons in the bin) may not be accurate but loss in weight is accurate. Thus, for calibration of a weigh feeder or for volumetric weigh feeding a loss in weight is well-qualified.

The next important weighing principle is the continuous measurement of material to constantly feed an accurate amount of material, the dynamic weighing with weigh feeder. Several principles are applied with different accuracy, different efforts for maintenance and different prices.

Thus when selecting the weigh feeder the following points must be taken into consideration:

- ◆ Accuracy required.
- ◆ Mechanical suitability for the material and the environment.
- ◆ Space availability (height and area). Especially building height can be reduced (cost saving) with certain weighing arrangements and weighing principles.
- ◆ Signal availability and signal transmission. (4-20 mA and digital signals or communication via a bus system).
- ◆ Maintenance that is time interval between calibration, access for calibration e.g. re-routing of material onto a lorry, cleaning required, complexity of the control, spare parts etc.
- ◆ Measurement principle.
- ◆ Silo discharge system. Most problems of inaccurate weighing arise from poor flowing material.

7.5.1 Belt weigher

The most common measuring principle applied in the cement industry is the belt weigher. A section of the belt runs over idlers supported by a frame section placed onto load cells.

The weight over this belt section multiplied with the speed represents the feed rate $Q = P * v$ whereas:

Q = feed rate [t/h]

P = weight per width [kg/m]

v = speed [m/h]

This principle is well-known and if maintained properly very accurate (error < 1%)

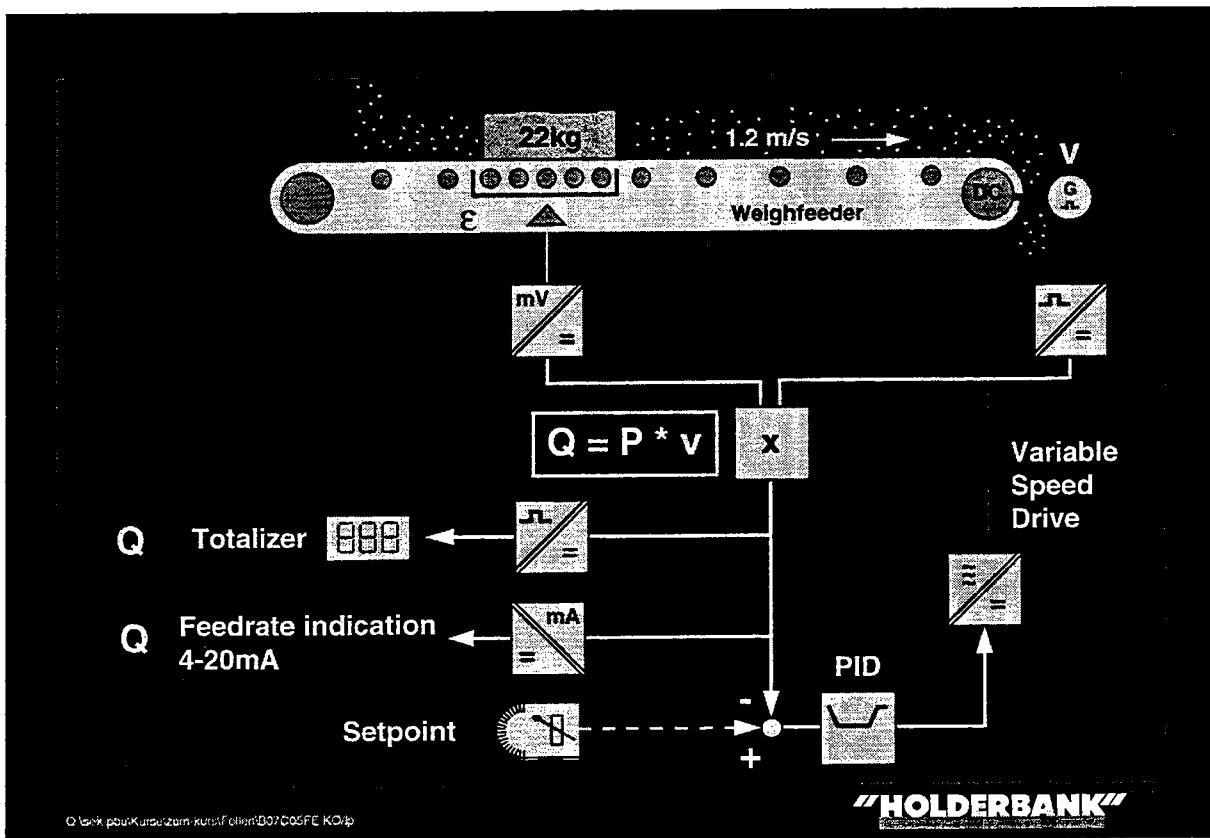

Also different methods of calibration are offered, but only the following are accurate and repeatable: Run for e.g. 5 minutes material onto a lorry, weigh the lorry and calculate the feed rate weight x 12 (if the calibration time was 5 min.). Thus when designing the weigh feeders a means to calibrate onto a lorry must be included or alternatively weigh bins above the feeders to calibrate with the loss in weight method which is a very accurate method too.

7.5.2 Gravimetric feed system

A gravimetric feed system is mainly used for coal feeders. This weighing system is complex but accurate. A bin on load cells is rapidly charge with material. The filling then stops and for n seconds the bin is emptied. (t_n = discharge time depending on bin size).

When reaching a certain low level the bin is recharged again and during this time the speed of the discharge feeder is maintained at the previous feed rate. The feed rate Q is calculated by the formula:

$$Q = \frac{m \cdot 3600 \text{ s/h}}{t_n}$$

m = loss of weight during t_n [kg]

t_n = discharge time [s]

Modern systems calculate the feed rate during a very short time period and take the whole time to calibrate the system. The accuracy of such a system is < 1%. The maintenance however is high and the system is complex.

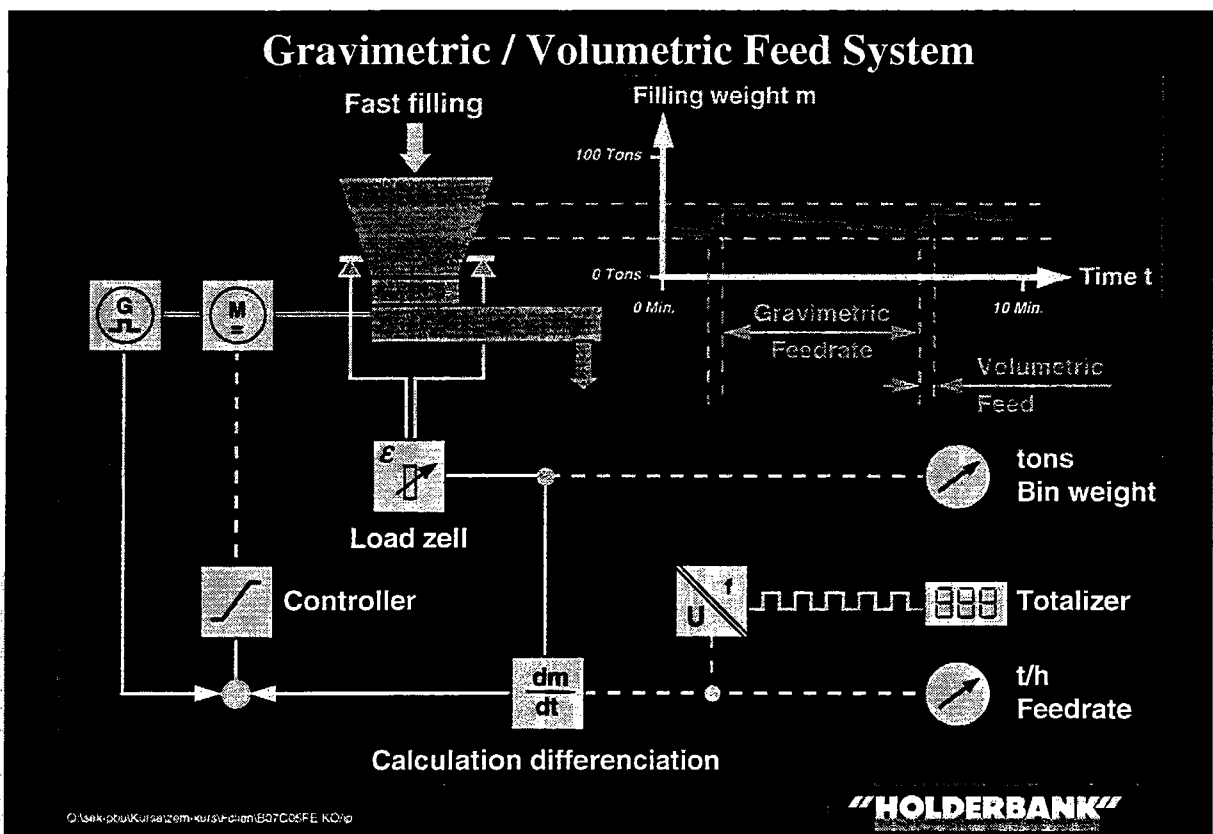

7.5.3 Volumetric feeders

A simple method is a volumetric feeder. The accuracy is largely dependent on the feeder itself and on the flow property of the material. Depending on the required accuracy, a periodic calibration onto a lorry is needed. If a higher accuracy is required a weigh bin has to be introduced prior to the feeder and a similar measuring method as mentioned in the gravimetric flow measurement has to be applied.

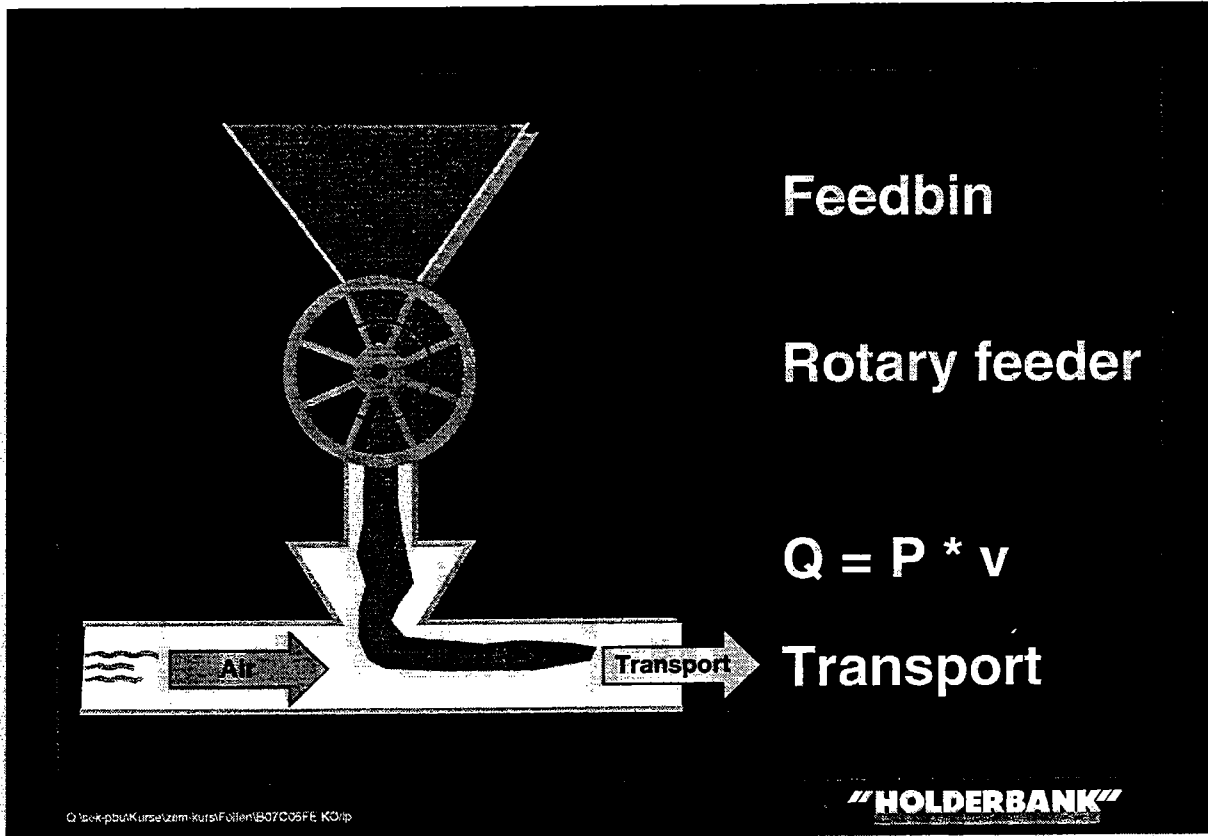

7.5.4 Impact flow meter

A controversial measurement is the weight measurement with an impact flow meter. Material flows on to a plate which in turn is placed on a load cell. The impact on to the plate is proportional to the impact created by a mass falling from a height h . The impact is in practice also depending on the flow properties of the material which in turn is depending on various factors. Thus, this measurement requires a fair amount of mechanical design around the actual measurement. Dedusting, the feed to and away from the impact flow meter are crucial for the accuracy of the measurement.

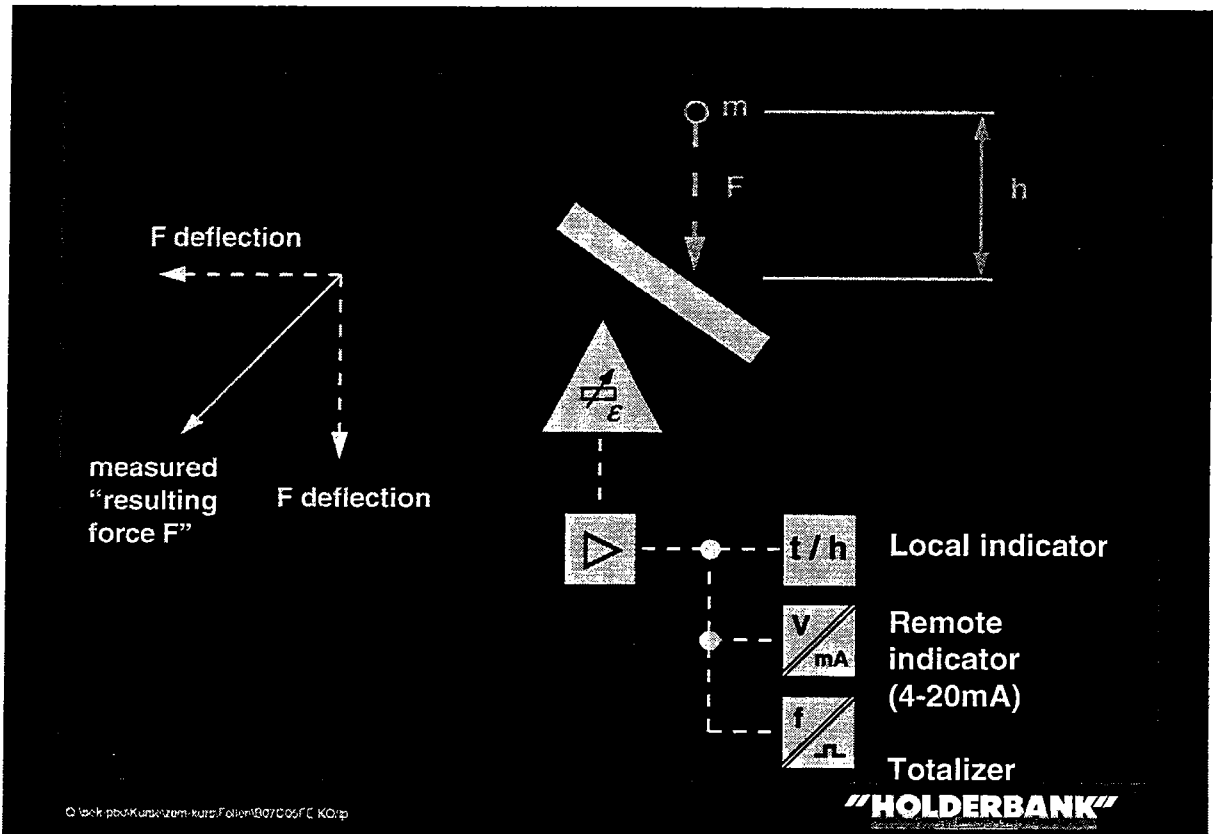

In practice the impact flow meter is mostly applied together with a pre bin arranged with load cells. This arrangement allows an automatically periodical calibration of the flow meter, in order to compensate sticking material at the plate.

7.5.5 Nuclear weigh feeder

Weighing with nuclear weigher is nothing new in the cement industry but is and remains a controversial measurement. Although, a simple and reliable measurement the import and the disposal of the nuclear source is problem. A nuclear weigher consists of a gamma source and a gamma ray detector. Both are connected on a mechanical frame which is located across the conveyor. The beauty is that almost any conveyor (e.g. belt, apron feeder, screw conveyor etc.) can be fitted with an A or C frame nuclear weigher. Even in an existing installation does the installation of an A or C frame seldom present a problem.

A nuclear weigh feeder determines the weight by measuring the absorption of the material. Every material absorbs radiation according the exponential law. The absorption is proportional to the thickness and the density of the material bed. The absorption is then related to the mass of the material which, when multiplied with the speed, results in the mass flow.

The main absorption (basic absorption A_g) is in many cases given by the construction. The absorption with a given density is then proportional with the bed thickness (A_m). To receive good results the absorption A_g should not be larger than 95%.

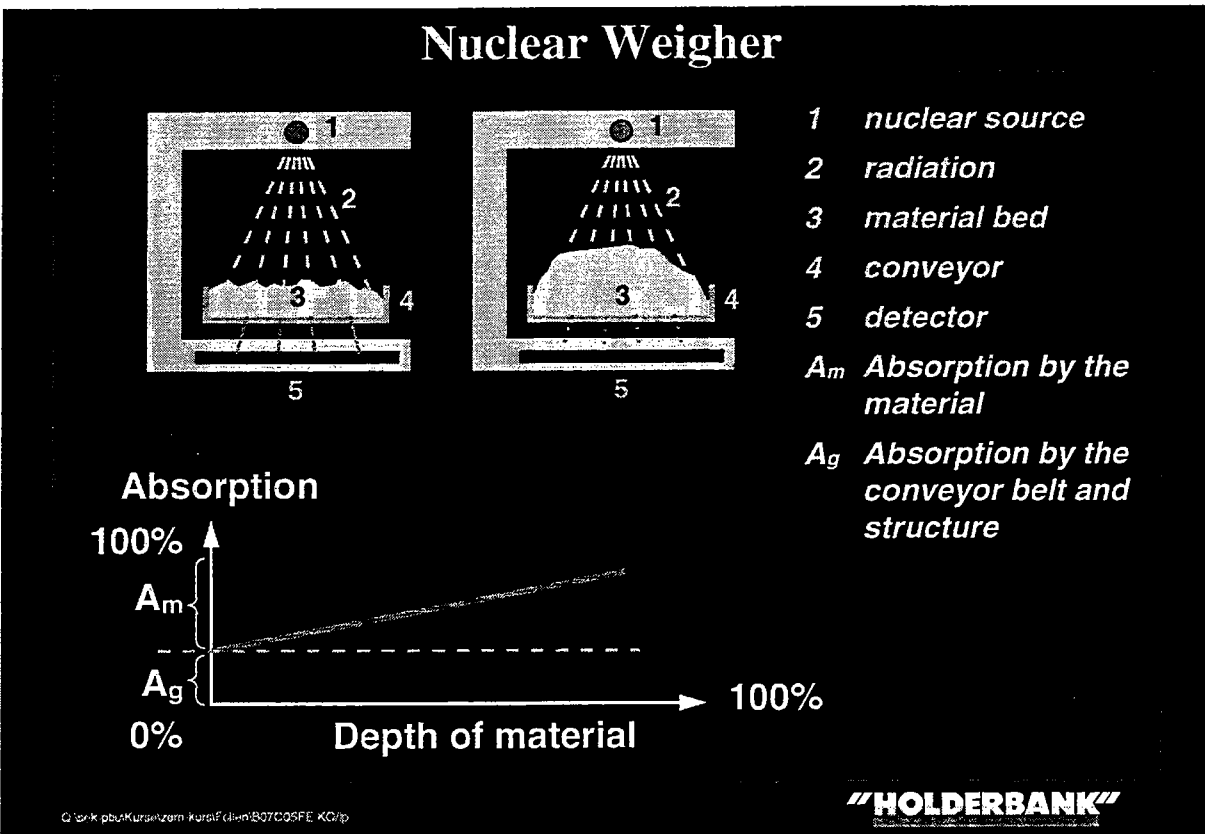

Due to a less thick material bed (3) the absorption measured by the detector (5) is lower. The absorption (2) by the conveyor (4) is remaining constant and calibrated as zero.

When installing an nuclear weigher the following points should be taken into consideration:

- ◆ import regulation for nuclear devices
- ◆ disposal of nuclear sources
- ◆ building and conveyer construction
- ◆ basic absorption (Ag)
- ◆ electronic with source decay compensation
- ◆ even material flow (an irregular bed which influences the measurement negatively)
- ◆ the initial accuracy is around 2% remaining constant even with hardly any maintenance.

7.5.6 Head flow meter

In an air lift the air pressure measured is more or less proportional to the amount of material transported. However, pressure influence other than the amount of material is coming from dedusting and from pressure changes from the system following the air lift (e.g. pre-heater and kiln). The head flow meter as an indication to the material flow is quite acceptable.

7.6 Analytical measurements

For further information, please refer to the appropriate paper “Quality assurance” in the material technology II.

7.7 Electrical energy and power measurements

7.7.1 Introduction

In the cement industry, the topic “Energy” will become more and more important. - In the past until today the price for electrical energy is still low enough that nobody cares to much. But the near future will show us the opposite. The energy consumption will still increase but the energy production cannot follow this rising demand. Thus a bottle-neck will occur. The power companies have already started to think about increasing energy prices and how to introduce new tariff structures (Energy Exchange). Consequently, we have at least to stabilise our energy consumption or, even better, decrease the consumption. The first step will be to **measure** before other steps can be taken. - The following chapter treats this topic.

7.7.2 Definition of energy and power

What is electrical energy?

Energy, generally, is stored work or the ability to perform work. Electric energy (W_{el}) is potential energy or expressed in an other way, the product of electric voltage (U) and electric charge (Q). The electric charge can be replaced by the product of current and time ($W_{el} = U * Q = U * I * t$; whereas I = current and t = time). The electric energy is comparable to energy of position in the mechanic that is:

- ◆ potential difference: height -> voltage U.
- ◆ quantity: weight -> electric charge Q.

The unit is volt-ampere-second [VAs] or in a more practical way kilo-watt-hour [kWh]. One kWh is equal to 3.6 MJ [860 kcal].

What is electric power?

To express performance the work to complete is related to the time required to do it. Similar, the more powerful a machine is, the more work can be done in a shorter time.

Thus, the power is proportional to the work and inverse proportional to the time to complete the job. The electric power (P) is the product of voltage (U) and current (I). At the first sight, there is no time any more in the formula, but the definition of the current is the relation between the transported charge quantity and the time. The electric power is comparable to the mechanical power. For example, the power of a hydro power plant is dependent on the height of fall (voltage) and the flux (current). - The unit is volt-ampere [VA] or more practical kilo-watt [kW].

Apparent, actual, reactance

The power companies bill in most cases the actual energy only. To avoid producing too much apparent energy, they demand a power factor correction between 0.87 and up to 0.9. Few power companies ask for a reactance energy meter and if certain values are surpassed adjust the bill accordingly. Some power companies bill the client already according the apparent energy (measured actual and reactive energy). And this may be the future method of accounting the client since a power company has to produce the apparent power and not only the actual power.

Using a mechanical diagram the three electrical components: apparent (resultant), actual (linear) and reactive (lateral) are explained.

The following picture explains the three different electrical components, apparent, actual and reactive current. Whether current, power or energy is used is immaterial for this example.

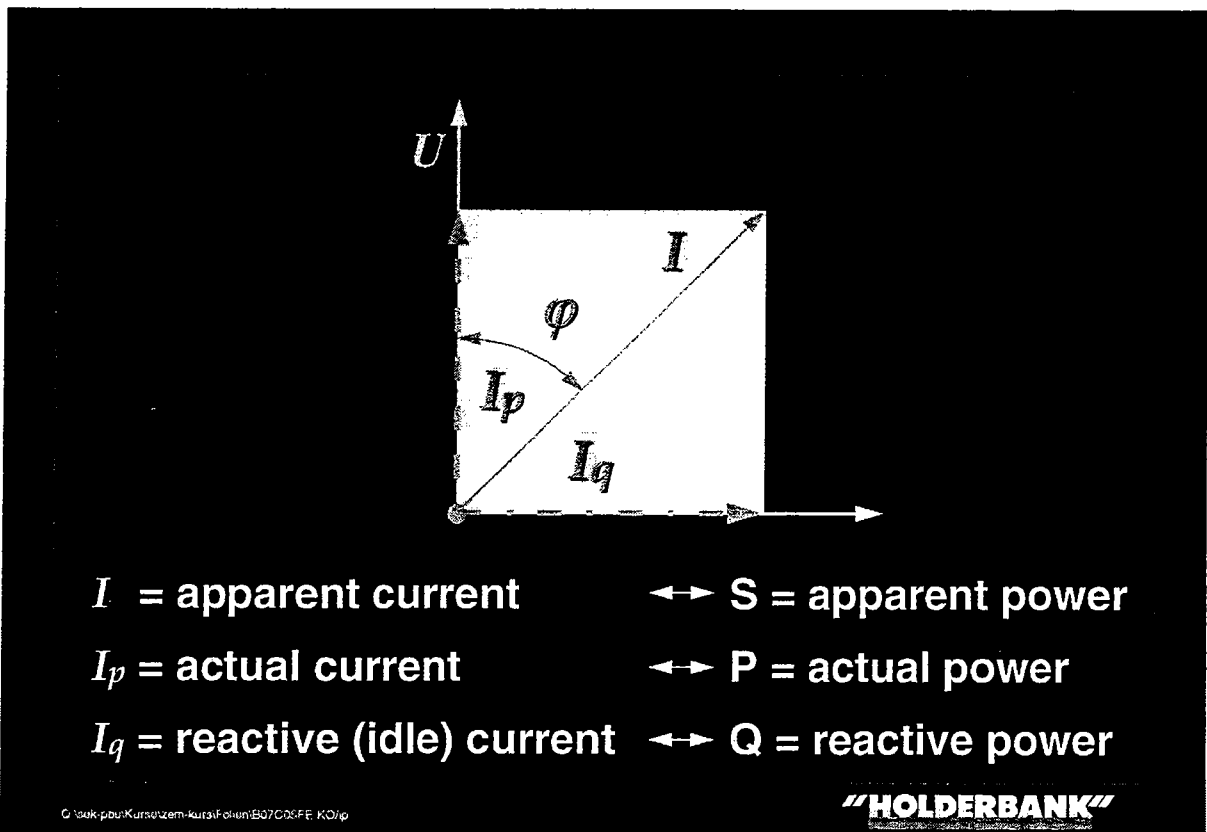

When looking at the force diagram the energy required to pull the spring is obviously the linear force F_p (electrical actual force). The spring is subjected to the following two forces:

- ◆ The lateral force F_q (electrically reactive force) which is not required.
- ◆ The resultant force F (electrically apparent force) has to be produced in order to gain sufficient momentum to pull the spring apart.

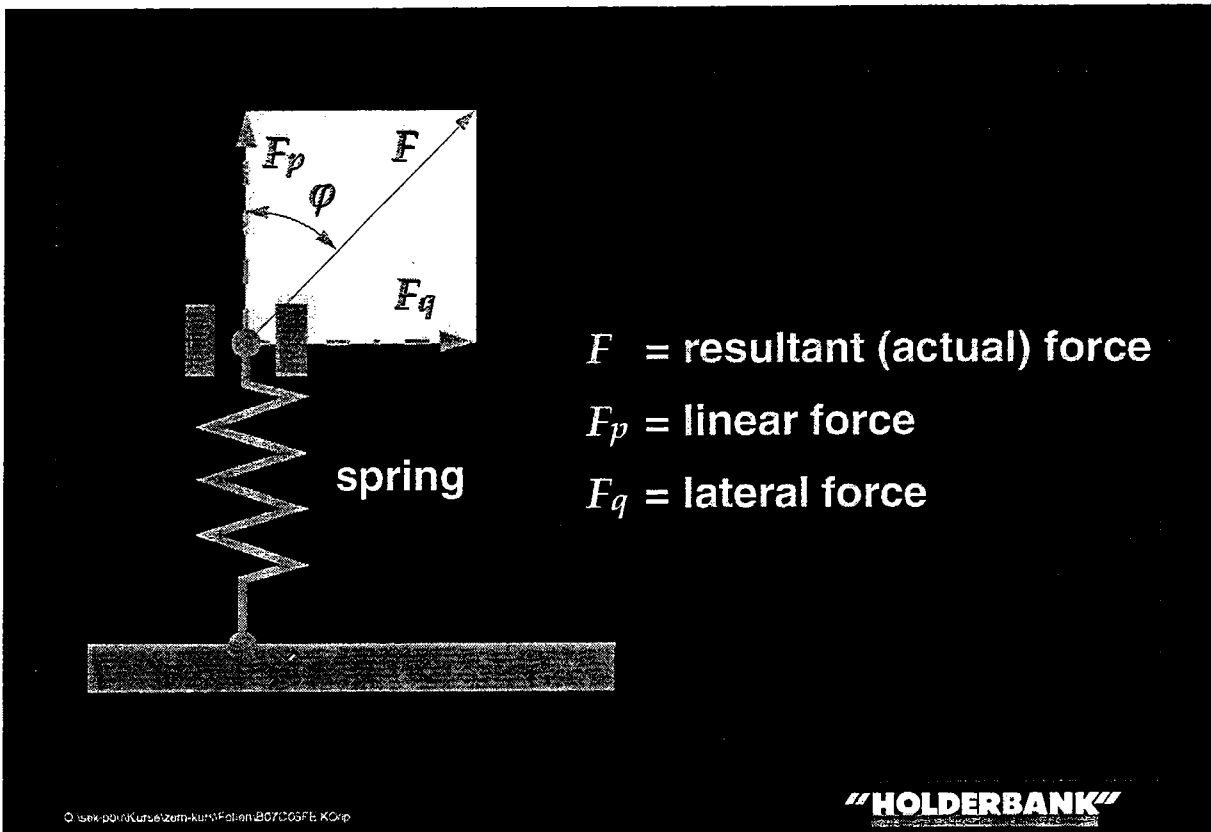

When measuring an electric circuit with a transducer the actual power is measured which is required to drive a machine. The power company in turn produces the apparent power. If the cosine ϕ is multiplied with the apparent power, the result is the actual power. The difference between the produced and the consumed power is the reactive power.

Apparent power	$S = U \cdot I$	[VA] or [kVA]
Actual power	$P = U \cdot I \cdot \cos \phi$ $P = S \cdot \cos \phi$	[W] or [kW]
Reactive power	$Q = U \cdot I \cdot \sin \phi$	[var] or [kvar]

Why measure?

As already mentioned, Electrical Energy contributes 20-30 % of the cement production cost. Thus electric energy is important factor as a **production component in the cement industry**. It is therefore imperative to measure the energy consumption in order to be able to determine solutions to save energy and thus maintaining the costs at least at the present level.

The energy consumption [kWh] and the specific energy consumption [kWh/t] are even units to compare for example departments in different plants or different types of machines (e.g. ball mill/vertical mill) to each other.

Where to measure?

Drawing E310015 shows the process structure in a cement plant which is ideally represented with the corresponding electrical structure and thus the ideal energy measuring points.

The measuring points are arranged in different levels:

- ◆ Main entrance-level; measuring point for charging by power company

At this point, the local power company measures the total consumption of the plant; it should also be a comparable-measuring of the plant; but attention, the result has not to be the same (two measuring circuits).

- ◆ Department-level;
- ◆ Every department should be measured separately to have an overview of the electric consumption in the different departments. Likewise for large consumers which are directly connected to the medium voltage distribution.
- ◆ Process/Non-process-level;
It is necessary to measure the non-process part to distinguish between process- and non-process-consumers. Since less measuring points are used for non-process measurement, costs can be reduced by measuring the
- ◆ Total - non-process = process. (see drawing E310015)
- ◆ Special consumer-level;
This level contains consumers of special interest from an energy point of view.

Energy-/power metering in a cement plant

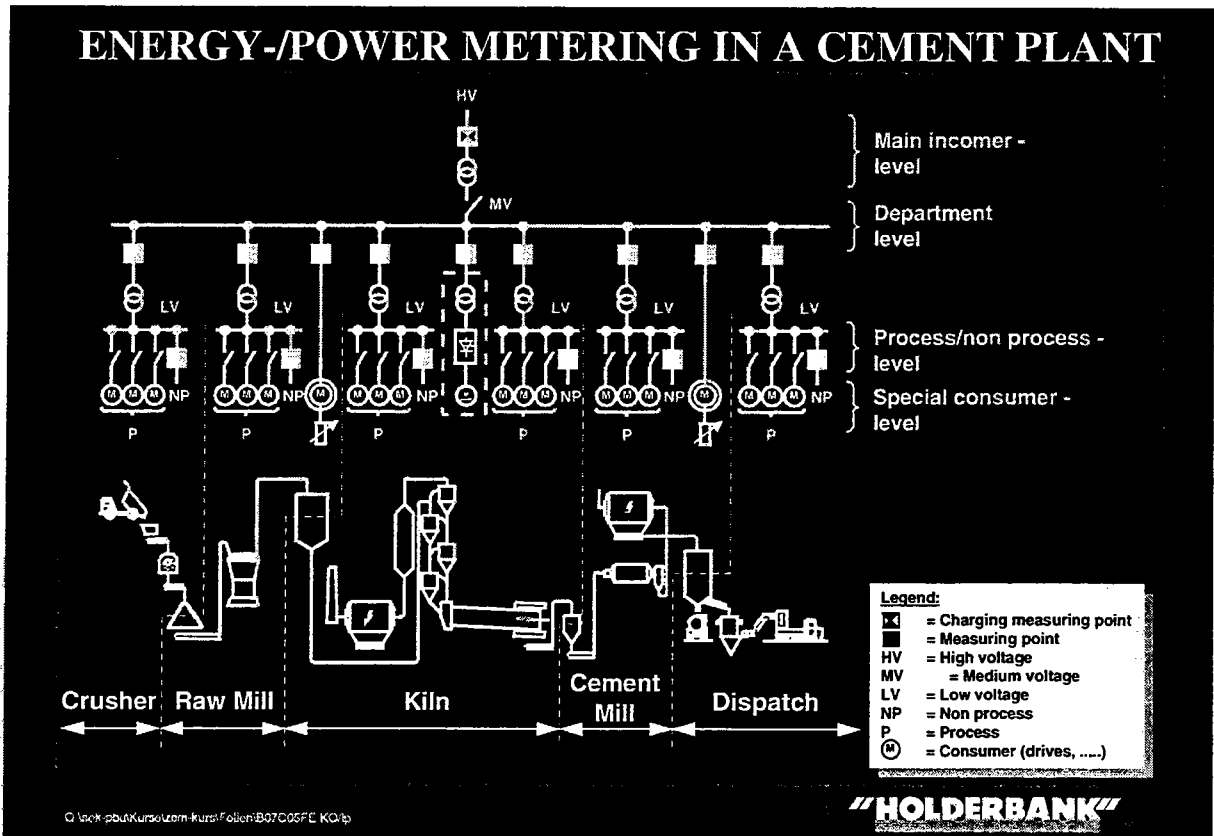

If all these measuring points are counted together, the total will be around 50. But in practice it is very difficult to find such an electric distribution. So in reality the amount of measuring points will increase to 500 points which will be rather costly. The conclusion is, that measuring starts with **proper electrical departments thus a proper distribution.**

How to measure energy?

Today there are two measurement principles for electric energy, a direct measuring method and an indirect one. - An important criterion is the measuring principle. The method applied depends on the kind of load, the connected voltage (voltage - and/or current transformer necessary) and the accuracy required. The figure F44942 shows different connection diagrams for the measuring method with kWh-meter. The same principle is utilised for a power transducer.

kWh-meter (direct measuring method)

The kWh-meter forms with the current-path and the voltage-path a mechanical torque, which is proportional to the electric power. This torque sets the metering disc in a corresponding number of turns per unit of time. The multiplication with the time to receive energy, follows with the addition of the number of rotations. The kWh-meter shall be equipped with an on/off output module. This module includes a pulse contact system and a pulse amplifier, suitable for further handling in a control system. For example; In the control system, the energy will be calculated with the time between two pulses. The practice shows that this "digital" method is not such exact than the method described below. - The above described measuring method is the principle of "Ferraris"-counter or eddy current motor.

Today more and more static kWh-meters are utilised. The same measuring method is done in an electronic way and not any more in an electro mechanical way, but there is still a pulse contact output.

Power transducer (indirect measuring method)

The power transducer measures current and voltage separately and calculates internally the electric power. The output signal is an analogue signal (4-20 mA) for electric power. *This analogue signal is an input in the control system* where the signal is integrated with the time which results in a more accurate measurement as opposed to a pulse-signal from a kWh-meter.

Process measurement display

The display of the energy measurement is just as important as the measurement itself. The measurement has to be displayed in form of power or energy as well as specific energy measurement (e.g. for the raw mill → kWh per ton of raw meal. The display is further described in chapter "MMI, Visualisation".

Power Measurement/Connection Diagrams for kWh-Meters

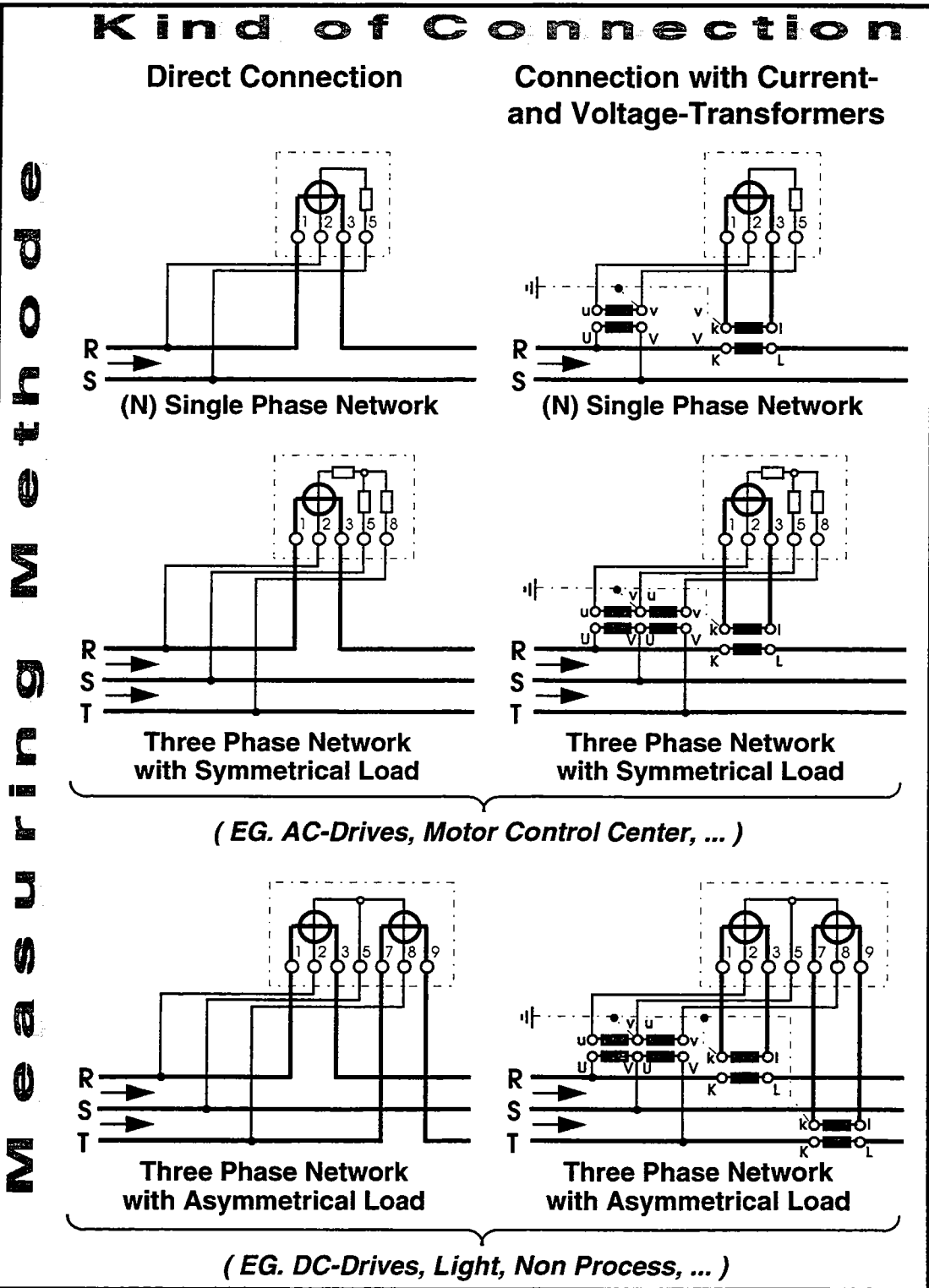

Q:\sek-pbu\Kurse\Zem-Kurs\Folien\B07C05FF KO/ip

7.8 Field devices

Just as important as analogue instruments are the on/off sensors, control and field devices. Most measuring principles as described in the previous sections are available as on/off devices. Few on/off sensors are available as smart sensors and even less can be connected to a bus (Profibus). The problems encountered with field devices are similar as with analogue instruments and the same provision has to be made as with the analogue instruments. Sensors like limit switches, pressure switches, speed switches etc. are available in different price classes. Do not feel tempted to buy cheap sensors as the money saved will be spent tenfold on maintenance and on down time. Only the best is good enough. And only the best installation will give acceptable performance. And where possible replace on/off sensors with analogue sensors.